

ILS/ILD Eletrobombas circuladoras simples ou duplas inline | Single or double circulating inline pumps

➤ APLICAÇÕES

Ar condicionado  
Indústria em geral  
Sistemas de irrigação

➤ MATERIAIS DE CONSTRUÇÃO

Corpo da bomba: Ferro fundido  
Impulsor: Ferro fundido  
Veio: Aço Inoxidável  
Empanque: Mecânico em Car/ SiC/ EPDM

➤ LIMITES DE UTILIZAÇÃO

Temperatura máxima do líquido: 130°C  
Pressão máxima de serviço: 10 bar  
Temperatura ambiente máxima: 40°C

➤ CARACTERÍSTICAS DO MOTOR

Tipo: TEFC  
Tensão: 3x400V  
Classe de isolamento: F  
Classe de proteção: IP55  
Rotação: 1450 ou 2900 rpm

➤ APPLICATIONS

Air conditioning  
Light industry in general  
Irrigation systems

➤ CONSTRUCTION MATERIALS

Pump body: Cast iron  
Impeller: Cast iron  
Shaft: Stainless steel  
Seal: Mechanical in Car/ SiC/ EPDM

➤ WORKING LIMITS

Liquid temperature: 130°C  
Maximum working pressure: 10 bar  
Maximum ambient temperature: 40°C

➤ MOTOR SPECIFICATIONS

Voltage: 3x400V  
Insulation class: F  
Protection class: IP55  
Rotation: 1450 or 2900 rpm



## ILS/ILD

A gama de bombas circuladoras **ILS/ILD** são de conceção em linha ("in-line"), de corpo simples (ILS) ou duplo (ILD) e de construção em ferro fundido. Possui características adequadas para aplicações em sistemas de ar condicionado bem como para a bombagem de líquidos em processos industriais.

The **ILS/ILD** range of circulating pumps is a In-line conception with single body (ILS) or double (ILD) made of cast iron. They are suitable for applications in air conditioning systems as well as for pumping of liquids in industrial processes.

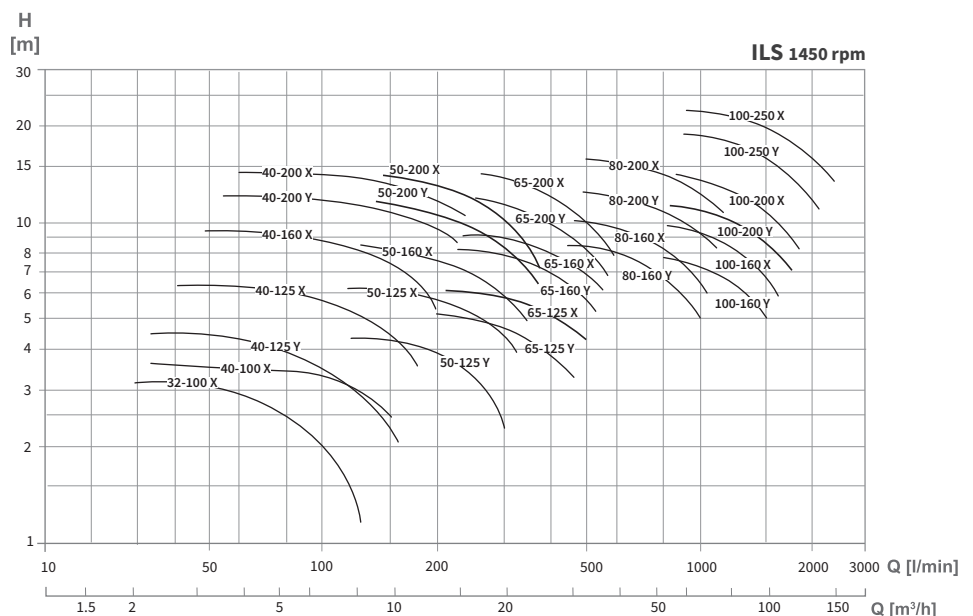
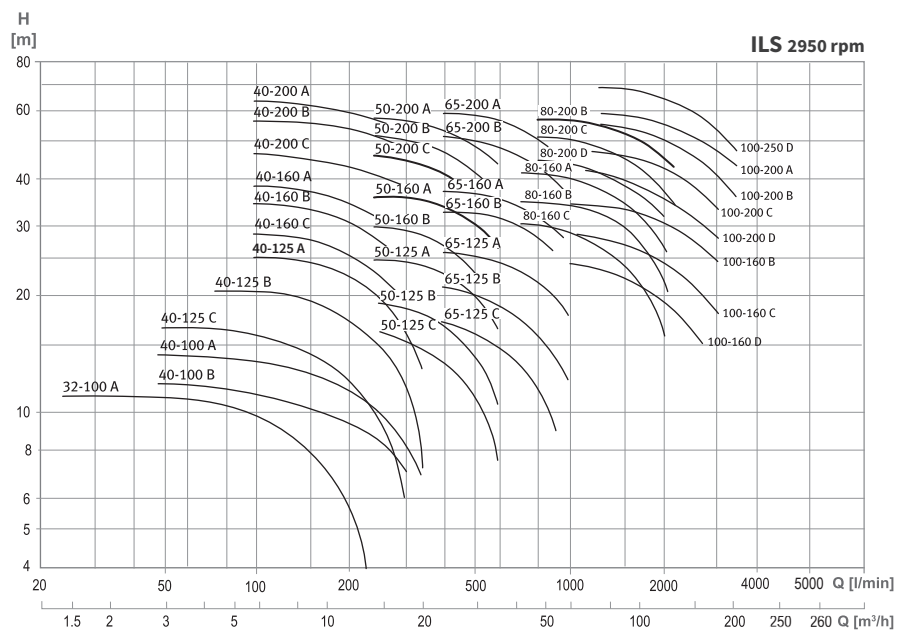

**Nota:** A bomba pode ser instalada na vertical ou na horizontal. Não instalar com o motor virado para baixo.  
*Note:* The pump can be installed vertically or horizontally. Please do not install with the motor turned down.

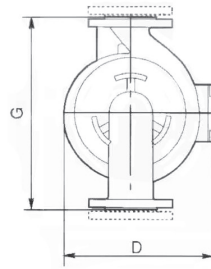
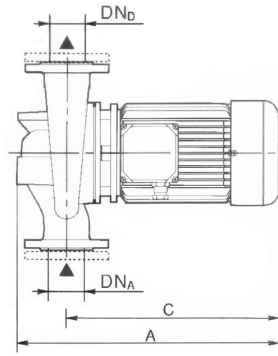

MODELO MODEL 1450 RPM	POTÊNCIA POWER (kW)	DNA / DND	DIMENSÕES   DIMENSIONS (mm)				PESO WEIGHT (Kg)
			A	C	D	G	
ILS 32x100X	0,3	32 PN6	395	330	172	220	12
ILS 40x100X	0,3	40 PN6	445	355	184	260	16
ILS 40x125Y	0,3	40 PN16	425	325	200	300	20
ILS 40x125X	0,3	40 PN16	425	325	200	300	20
ILS 40x160X	0,4	40 PN16	425	325	215	320	23
ILS 40x200Y	0,8	40 PN16	445	345	245	380	30
ILS 40x200X	1,1	40 PN16	445	345	245	380	30
ILS 40x250Y	1,1	40 PN16	485	385	330	440	51
ILS 40x250X	1,5	40 PN16	485	385	330	440	51
ILS 50x125Y	0,3	50 PN16	435	325	210	320	21
ILS 50x125X	0,4	50 PN16	435	325	210	320	22
ILS 50x160X	0,6	50 PN16	435	325	220	340	25
ILS 50x200Y	1,1	50 PN16	495	385	280	400	36
ILS 50x200X	1,1	50 PN16	495	385	280	400	36
ILS 50x250Y	1,5	50 PN16	510	385	330	440	52
ILS 50x250X	2,2	50 PN16	550	425	330	440	56
ILS 65x125Y	0,4	65 PN16	465	325	215	360	25
ILS 65x125X	0,6	65 PN16	465	325	215	360	26
ILS 65x160Y	0,8	65 PN16	485	345	240	400	32
ILS 65x160X	1,1	65 PN16	485	345	240	400	33
ILS 65x200Y	1,1	65 PN16	525	385	285	440	38
ILS 65x200X	1,5	65 PN16	525	385	285	440	40
ILS 65x250Y	2,2	65 PN16	525	385	285	475	38
ILS 65x250X	3,0	65 PN16	525	385	285	475	40
ILS 80x160Y	1,1	80 PN16	545	385	280	440	38
ILS 80x160X	1,5	80 PN16	545	385	280	440	40
ILS 80x200Y	2,2	80 PN16	585	425	305	500	51
ILS 80x200X	3,0	80 PN16	585	425	305	500	57
ILS 80x250Y	4,0	80 PN16	700	540	353	530	84
ILS 80x250X	5,5	80 PN16	700	540	353	530	94
ILS 100x160Y	1,5	100 PN16	575	385	285	525	45
ILS 100x160X	2,2	100 PN16	615	425	295	525	50
ILS 100x200Y	3,0	100 PN16	615	425	315	550	66
ILS 100x200X	4,0	100 PN16	625	435	315	550	73
ILS 100x250Y	5,5	100 PN16	730	540	360	600	96
ILS 100x250X	7,5	100 PN16	730	540	360	600	106
ILS 125x250W*	5,5	125 PN16	745	550	415	620	132
ILS 125x250Z*	5,5	125 PN16	745	550	415	620	132
ILS 125x250Y*	7,5	125 PN16	745	550	415	620	135
ILS 125x250X*	11,0	125 PN16	745	550	415	620	138
ILS 150x250W*	7,5	150 PN16	775	555	460	700	154
ILS 150x250V*	11,0	150 PN16	775	555	460	700	158
ILS 150x250Z*	11,0	150 PN16	775	555	460	700	162
ILS 150x250Y*	15,0	150 PN16	975	755	510	700	201
ILS 150x250X*	15,0	150 PN16	975	755	510	700	201

MODELO MODEL 2900 rpm	POTÊNCIA POWER (kW)	DNA / DND	DIMENSÕES   DIMENSIONS (mm)				PESO WEIGHT (Kg)
			A	C	D	G	
ILS 32x100A	0,4	32 PN6	395	330	172	220	12
ILS 40x100B	0,6	40 PN6	485	330	182	260	16
ILS 40x100A	0,8	40 PN6	485	330	182	260	16
ILS 40x125C	0,8	40 PN16	425	325	200	300	24
ILS 40x125B	1,1	40 PN16	445	345	211	300	25
ILS 40x125A	1,5	40 PN10	445	345	211	300	26
ILS 40x160C	2,2	40 PN16	485	385	257	320	30
ILS 40x160B	3,0	40 PN16	485	385	257	320	35
ILS 40x160A	3,0	40 PN16	485	385	257	320	37
ILS 40x200C	4,0	40 PN16	525	425	286	380	50
ILS 40x200B	5,5	40 PN16	535	435	286	380	55
ILS 40x200A	7,5	40 PN16	535	435	286	380	56
ILS 50x125C	1,5	50 PN16	455	345	221	320	27
ILS 50x125B	2,2	50 PN16	455	345	221	320	28
ILS 50x125A	3,0	50 PN16	495	385	252	320	32
ILS 50x160B	3,0	50 PN16	495	385	262	340	32
ILS 50x160A	4,0	50 PN16	535	425	272	340	42
ILS 50x200C	5,5	50 PN16	545	435	290	400	56
ILS 50x200B	7,5	50 PN16	545	435	290	400	57
ILS 50x200A	7,5	50 PN16	650	540	320	400	64
ILS 65x125C	2,2	65 PN16	525	385	257	360	35
ILS 65x125B	3,0	65 PN16	525	385	257	360	39
ILS 65x125A	4,0	65 PN16	565	425	267	360	43
ILS 65x160B	5,5	65 PN16	575	435	281	400	54
ILS 65x160A	7,5	65 PN16	680	540	306	400	61
ILS 65x200B	11,0	65 PN16	680	540	320	440	70
ILS 65x200A	15,0	65 PN16	680	540	320	440	77
ILS 80x160C	11,0	80 PN16	700	540	315	440	72
ILS 80x160B	15,0	80 PN16	700	540	315	440	79
ILS 80x160A	15,0	80 PN16	700	540	315	440	85
ILS 80x200D	15,0	80 PN16	700	540	330	500	91
ILS 80x200C	18,5	80 PN16	860	700	375	500	124
ILS 80x200B	22,0	80 PN16	860	700	375	500	142
ILS 100x160D	11,0	100 PN16	730	540	320	525	76
ILS 100x160C	15,0	100 PN16	730	540	320	525	84
ILS 100x160B	15,0	100 PN16	730	540	320	525	91
ILS 100x200D	18,5	100 PN16	890	700	386	550	135
ILS 100x200C	22,0	100 PN16	890	700	386	550	153
ILS 100x200B	30,0	100 PN16	995	805	413	550	195
ILS 100x200A	37,0	100 PN16	995	805	413	550	213
ILS 100x250D	37,0	100 PN16	995	805	433	600	220

\*modelos sob consulta

\* models on request

ILS/ ILD Eletrombas circuladoras simples ou duplas inline | Single or double circulating inline pumps

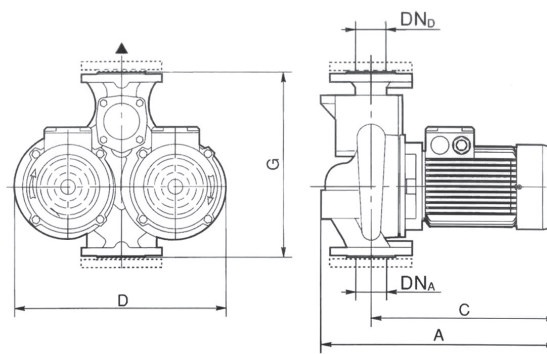
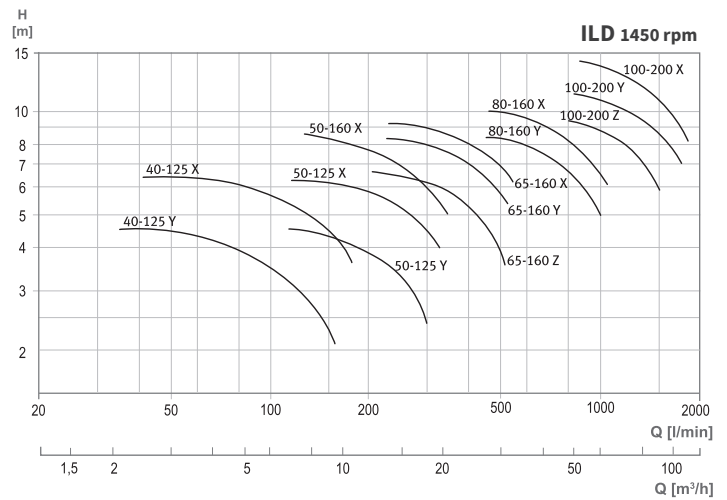
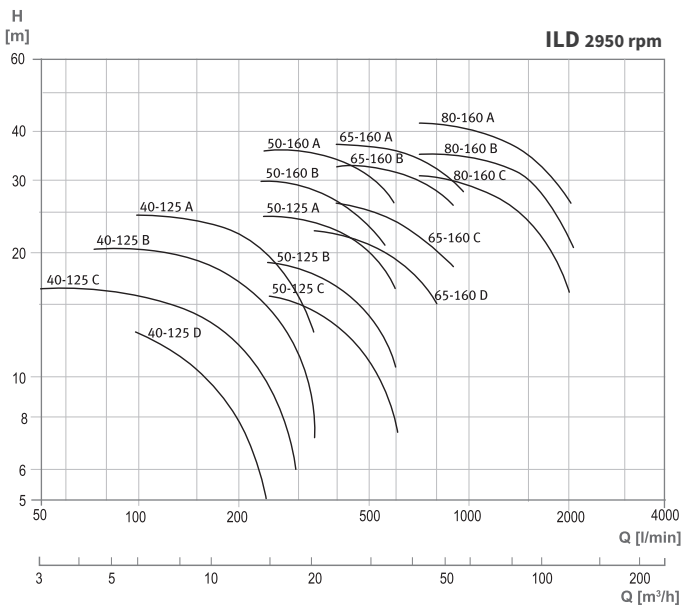

MODELO MODEL	POTÊNCIA POWER (kW)	DNA /DND	DIMENSÕES   DIMENSIONS (mm)				PESO WEIGHT (Kg)
			A	C	D	G	
ILD 1450 rpm							
ILD 40x125X	0,3	40	425	325	397	340	41
ILD 40x125Y	0,3	40	425	325	397	340	41
ILD 40x125Z	0,3	40	425	325	397	340	41
ILD 50x125Y	0,3	50	435	325	427	365	44
ILD 50x125X	0,4	50	435	325	427	365	46
ILD 50x160X	0,6	50	435	325	480	410	52
ILD 65x160Z	0,8	65	475	345	543	450	65
ILD 65x160Y	0,8	65	575	345	543	450	65
ILD 65x160X	1,1	65	475	345	543	450	67
ILD 80x160W	0,8	80	485	335	550	510	72
ILD 80x160Z	1,1	80	485	335	550	510	74
ILD 80x160Y	1,1	80	535	385	550	510	79
ILD 80x160X	1,5	80	535	385	550	510	83
ILD 100x200W	1,5	100	535	355	670	630	130
ILD 100x200Z	2,2	100	615	435	670	630	140
ILD 100x200Y	3,0	100	615	435	670	630	150
ILD 100x200X	4,0	100	615	435	670	630	170

MODELO MODEL	POTÊNCIA POWER (kW)	DNA /DND	DIMENSÕES   DIMENSIONS (mm)				PESO WEIGHT (Kg)
			A	C	D	G	
ILD 2900 rpm							
ILD 40x125D	0,8	40	425	325	397	340	50
ILD 40x125C	0,8	40	425	325	397	340	50
ILD 40x125B	1,1	40	445	345	397	340	52
ILD 40x125A	1,5	40	445	345	397	340	54
ILD 50x125C	1,5	50	455	345	427	365	56
ILD 50x125B	2,2	50	495	385	427	365	63
ILD 50x125A	3,0	50	495	385	427	365	66
ILD 50x160B	3,0	50	495	385	480	410	67
ILD 50x160A	4,0	50	535	425	480	410	86
ILD 65x160D	3,0	65	515	385	543	450	81
ILD 65x160C	4,0	65	565	435	543	450	101
ILD 65x160B	5,5	65	565	435	543	450	108
ILD 65x160A	7,5	65	670	540	543	450	125
ILD 80x160D	7,5	80	690	540	550	510	148
ILD 80x160C	11,0	80	690	540	550	510	162
ILD 80x160B	15,0	80	690	540	550	510	175
ILD 80x160A	15,0	80	640	540	550	510	187
ILD 100x200D	11,0	100	720	540	670	630	200
ILD 100x200C	15,0	100	720	540	670	630	214
ILD 100x200F	15,0	100	720	540	670	630	214
ILD 100x200A	15,0	100	720	540	670	630	230
ILD 100x200B	15,0	100	720	540	670	630	230
ILD 100x200E	15,0	100	720	540	670	630	230